

THE EAZY WIRING SYSTEM

THIS KIT CONTAINS THE FOLLOWING

- 1 PRE-WIRED FUSE PANEL WITH 17 FUSES AND 1 BREAKER
- 2 SIGNAL FLASHERS AND 1 PRE-WIRED RELAY CONNECTOR WITH HORN RELAY.
- 2 PRE-WIRED HEADLIGHT PLUGS
- 1 PRE-WIRED LATE GM ALTERNATOR PLUG.
- 2 PRE-WIRED GM COLUMN IGNITION SWITCH PLUGS
- 1 PRE-WIRED DIMMER SWITCH PLUG
- 2 GM TURN-SIGNAL CONNECTORS FOR THE PRE-TERMINATED WIRES (3 7/8" AND 4 1/4")
- 1 FUSIBLE LINK (3" BLACK WIRE WITH RING TERMINAL
- 1 LARGE GROMMET
- 30 PLUS MISCELLANEOUS INSULATED TERMINALS AND SOME SMALL CABLE TIES
- 2 LOOSE WIRES (NUETRAL SAFETY SWITCH WIRE AND PANEL LIGHT WIRE)

STEP #1 READ THESE INSTRUCTIONS before starting this installation. These instructions were developed after installing this system in over a dozen different vehicles and should make this a quick and **EAZY** job.

To aid you we have used **BOLD PRINT** to note **IMPORTANT** items and provided general diagrams for **FORD, GM** and **MOPAR**. There is also a **DO'S** and **DON'TS** section that you may find useful. Please remember that these are **GENERAL INSTRUCTIONS** for your **UNIQUE** and **SPECIFIC** vehicle and you may need to **MODIFY** them for your application. Also whenever using **AFTER-MARKET** or **SPECIALITY** equipment, always use the diagrams **PROVIDED WITH** that equipment.

This **WORKBOOK** is designed for both our labeled and color-coded harnesses. Whenever a specific wire is referred to, it will be displayed with its **LABEL** then it's **COLOR**. You are to use the destination that applies to the kit you purchased. If a diagram shows **ONLY** a color **OR** a label then that wire is **NOT PROVIDED** by this kit. An example of this would be **GROUND WIRES** which we **DO NOT** provide. We do recommend the use of black for ground wires on our color-coded harness and white on our labeled black harness to eliminate possible confusion.

Remember this is a **WORKBOOK!!!** So make use of the blank space we provide for your notes. Write things down so you won't forget.

STEP #2 COMPLETE THE WORK SHEET at the back of this workbook. This should be done while looking at the vehicle, so that you can identify what accessories you will be using and what switches will be necessary. Here is where **A LITTLE PLANNING WILL SAVE A LOT OF TIME.**

The **WORK SHEET** has been divided into the same 4 basic sections that make-up your harness. They are the **FRONT SECTION, DASH SECTION, STEERING COLUMN SECTION** and **TAIL SECTION.**

For each section compare the list of wires to your application and note if it will be **USED, MOVED** or **REMOVED**. Before marking wires to be removed consider accessories you may want to add at a later time or those not provided for by this kit. The design of your vehicle may require some of the wires to be moved from one section to another. (An example of this would be, if the horn was mounted on the rear of the car, you would want to move the **HORN = GREEN** wire to the tail section.) When marking a wire to be moved **DON'T FORGET** to **WRITE IT** into the new section in the extra spaces provided. The extra spaces should also be used for any extra wires you may need to add, such as ground wires.

STEP #3 PREPARE THE HARNESS FOR INSTALLATION.

For this you will need a **LARGE CLEAR WORK AREA** to spread out the harness. (The floor next to the project car works well.) Your harness, as purchased, will have each of the **4 SECTIONS** coiled and tied with cable ties. When working with the harness, it is **VERY IMPORTANT NOT TO REMOVE THE 3 CABLE TIES CLOSEST TO THE FUSE PANEL.**

Start with the largest coil of wires. That will be the **FRONT SECTION**, so remove the cable ties and uncoil the wires toward the front of the vehicle. The next largest coil of wires will be the **TAIL SECTION**. Cut off the cable ties and uncoil those wires toward the rear of the vehicle. The remaining coils of wires are the **DASH SECTION** and the **STEERING COLUMN SECTION**. The **STEERING COLUMN SECTION** is the one with the pre-attached plugs and will not need to be changed in most applications. Remove the cable ties from the **DASH SECTION** and uncoil those wires to the side of the **FUSE PANEL**.

Now using the **WORK SHEET** that you completed in **STEP #2**, start by removing any unused wires. Work one section at a time and remove those wires **ONE WIRE AT A TIME** by pulling them through the remaining harness cable ties. (**REMEMBER DO NOT REMOVE THE 3 TIES NEAREST THE FUSE PANEL.**) Unused wires that come directly from the **FUSE PANEL** are **HOT LEADS** and should be cut as **CLOSE** to the back of the panel as possible. Use **CAUTION** and only cut wires that you are sure you will **NEVER NEED!!**

After removing all unused wires from all sections, move on to those wires that you noted you would have to move from one section to another. Working one wire at a time move those wires to their new sections by pulling them out of their original section and passing them through the harness ties into their new sections.

Now, a section at a time, add any wires you noted you would need that are **NOT PROVIDED** in your kit. (Note--you can use the wire you removed, but **KEEP NOTES** so as not to get **CONFUSED**.)

The last part of this step is to compare the **WORK SHEET** to the harness as you have it now prepared. If everything is accounted for, use cable ties and recoil the sections one at a time. If the ties nearest the panel are loose either tighten them or replace them as necessary.

STEP #4 MOUNTING THE FUSE PANEL The **FUSE PANEL** of our standard harness is designed to be mounted under the dash on the driver's side of the vehicle.

The **FUSE PANEL** should be mounted securely to a **FLAT SURFACE**. Care should be taken to keep it and the wires away from **MOVING OBJECTS** such as gas and brake controls and the panel **SHOULD BE ACCESSIBLE** in case you ever blow a fuse. When selecting the panel location make sure that the **STEERING COLUMN SECTION WILL REACH YOUR COLUMN**.

After selecting the location for the **FUSE PANEL**, determine the best place to mount the horn relay that's pre-wired to the panel. We have provided ample length so that you may mount the relay anywhere near the panel.

Now that the **FUSE PANEL** and **HORN RELAY** are mounted, note where the **FRONT SECTION** wires exit the panel. Find a spot on the fire wall where these wires can enter the **ENGINE COMPARTMENT** without interfering with other components, such as brake boosters, wipers, the engine, steering gear and etc. At that spot drill a **1 1/4" HOLE** and install the grommet provided in your kit.

As the last part of this step, remove the cable ties you put on the **FRONT SECTION** wires and pass them through the grommet into the engine compartment **ONE WIRE AT A TIME**.

STEP #5 ROUTING AND ATTACHING THE WIRES. In this step you will be completing the job by terminating all those loose ends. As before this will be done section by section. We suggest you start with the **TAIL SECTION** and end with the **DASH SECTION**. Each section has its own set of instructions and we suggest you review the **DO'S** and **DON'TS** page and your **WORK SHEET** before starting each section. As you complete each section use cable ties to group the wires together and at points where wires branch off from the harness.

The **TAIL SECTION** harness is designed to be routed to the back of the vehicle inside along the floor. The wires can be taped to the floor or run under the driver's side door sills. They need to be routed where they **WON'T BE WALKED ON** and where the seats won't interfere. At the rear of the vehicle you will attach the wires to your lights, gas tank sender, and fuel pump as indicated on the **TAIL SECTION DIAGRAM**. Please note also that the **DOMELIGHT** power wire is included in the **TAIL SECTION**.

The **FRONT SECTION** wires include the front lighting, engine and accessories normally mounted on the front of the vehicle. For this section start by separating the **ENGINE** wires from the rest. When installing the front lighting and accessory wires follow the **FRONT LIGHTING DIAGRAM**. When installing the **ENGINE WIRING** use the diagram from the **FORD, GM** or **MOPAR** section that comes closest to your vehicle. Remember when connecting the 10 ga. **SOLENOID PWR = RED** wire to use the **FUSIBLE LINK** provided in your kit. Failure to install the **FUSIBLE LINK VOIDS ANY AND ALL WARRANTY** on this harness system. If you are using an **AMP METER** please follow the **AMP METER** section on the **DASH DIAGRAM**.

The **STEERING COLUMN SECTION** has the wires for your turn signals, ignition switch and dimmer switch. The plugs on these wires are for a **GM STEERING COLUMN** that has a column mounted ignition switch. If you are using that type of column, plug the black and clear plugs into the ignition switch. The dimmer switch plug will fit a floor mounted dimmer or the GM column mounted dimmer. The turn signal wires are pre-terminated and you will be using the diagram in the **GM SECTION** to determine the correct plug and order that the wires should be installed. Note that the plugs are letter coded to help.

If you are using a **LATE MODEL GM VAN** type column the turn signals will match the plugs in your kit but you will have to use **IGNITION SWITCH DIAGRAM** in the **DASH DIAGRAM**.

If you are using a **FORD** or **MOPAR COLUMN** use the diagrams in the **FORD** and **MOPAR SECTIONS**. But **REMEMBER** because they change colors often, these interchanges may **NOT** match your column. If the colors don't match or you're using something not listed, you may have to sort the turn signal wires out with an ohm meter. Most original ignition switches are marked on the back of the switch.

The **DASH SECTION** contains the wires for the gauges, the headlight switch, radio power leads, heater, wiper and cooling fan switches. The order you install these wires depends greatly on your dash configuration. Here it is best to start working from the driver's side of the dash toward the passenger's side. Use the cable ties provided in your kit to tie up the harness as you go.

By now you should be out of wires. All that remains is a simple start up procedure. Start by turning **OFF ALL ACCESSORIES**. Place the Ignition switch in the **OFF** position and close the doors to make sure the dome light is off. Now connect the **POS. BATTERY CABLE**. **BEFORE** connecting the **NEG. CABLE** you should check for a current draw. This can be done easily with a test light connected between the neg. battery post and the neg. battery cable. No light—no draw. If you have no draw or just a really dim light, it is safe to connect the neg. battery cable and start checking the system.

We hope that you found this kit and these instructions an **EASY** way to wire your project.

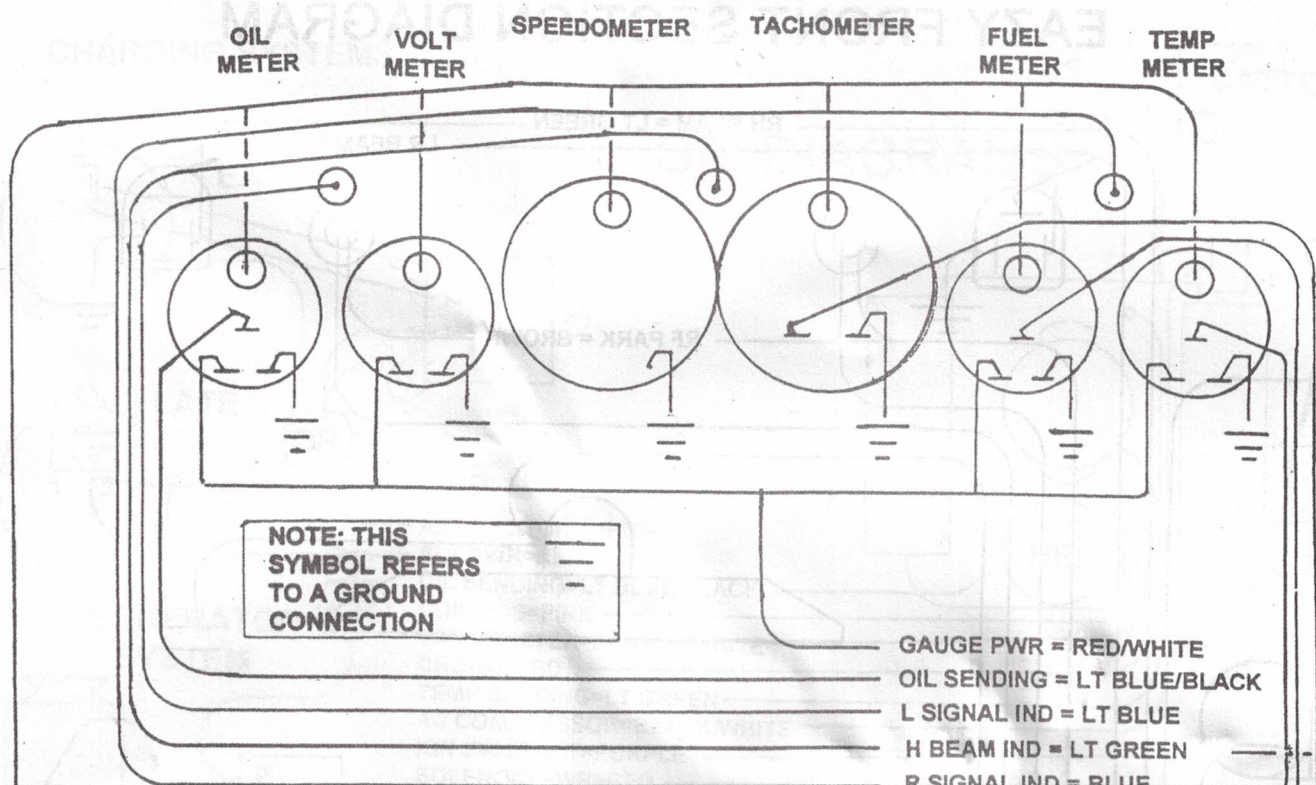

- Gauge PWR = RED/WHITE
- OIL SENDING = LT BLUE/BLACK
- L SIGNAL IND = LT BLUE
- H BEAM IND = LT GREEN
- R SIGNAL IND = BLUE
- TEMP SENDING = GREEN
- FUEL GAUGE = PINK
- TACHOMETER = PURPLE/WHITE
- HEADLIGHT PWR = RED/BLACK
- LF PARK = BROWN

EAZY DASH DIAGRAM

INSTRU PNL LGT = BROWN

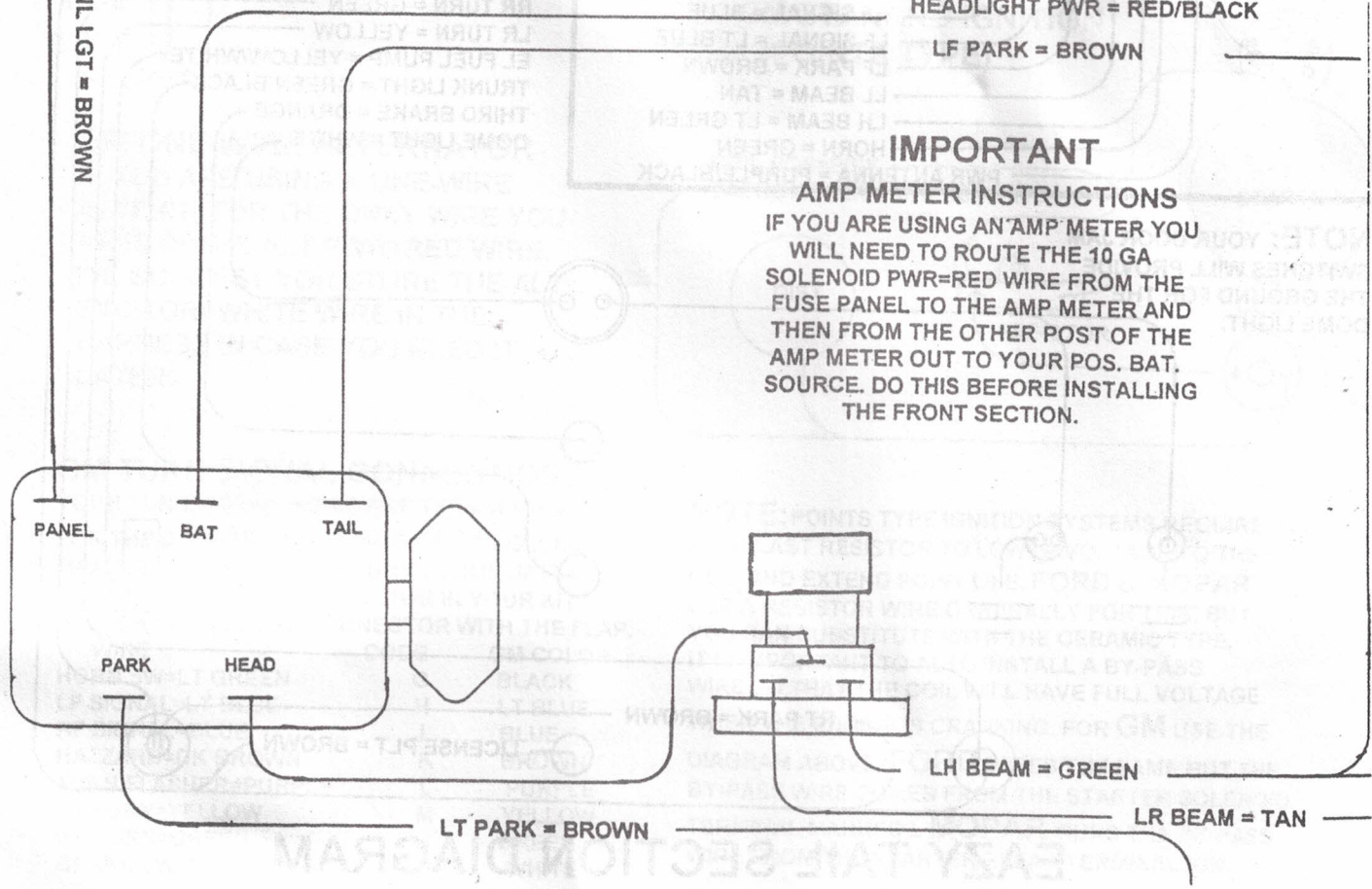

IMPORTANT

AMP METER INSTRUCTIONS
 IF YOU ARE USING AN AMP METER YOU WILL NEED TO ROUTE THE 10 GA SOLENOID PWR=RED WIRE FROM THE FUSE PANEL TO THE AMP METER AND THEN FROM THE OTHER POST OF THE AMP METER OUT TO YOUR POS. BAT. SOURCE. DO THIS BEFORE INSTALLING THE FRONT SECTION.

EAZY FRONT SECTION DIAGRAM

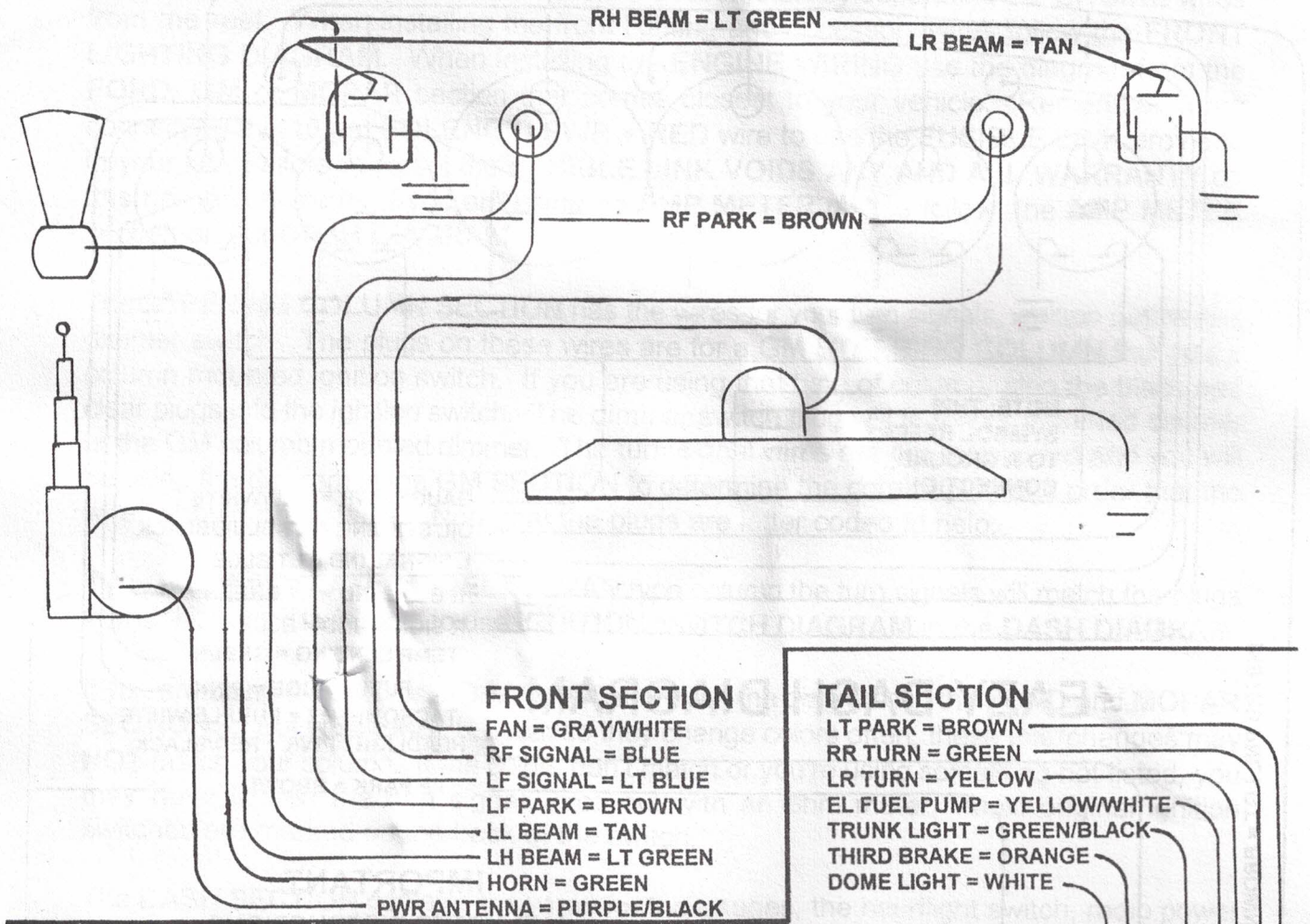

FRONT SECTION

- FAN = GRAY/WHITE
- RF SIGNAL = BLUE
- LF SIGNAL = LT BLUE
- LF PARK = BROWN
- LL BEAM = TAN
- LH BEAM = LT GREEN
- HORN = GREEN
- PWR ANTENNA = PURPLE/BLACK

TAIL SECTION

- LT PARK = BROWN
- RR TURN = GREEN
- LR TURN = YELLOW
- EL FUEL PUMP = YELLOW/WHITE
- TRUNK LIGHT = GREEN/BLACK
- THIRD BRAKE = ORANGE
- DOME LIGHT = WHITE

NOTE: YOUR DOOR JAM SWITCHES WILL PROVIDE THE GROUND FOR THE DOME LIGHT.

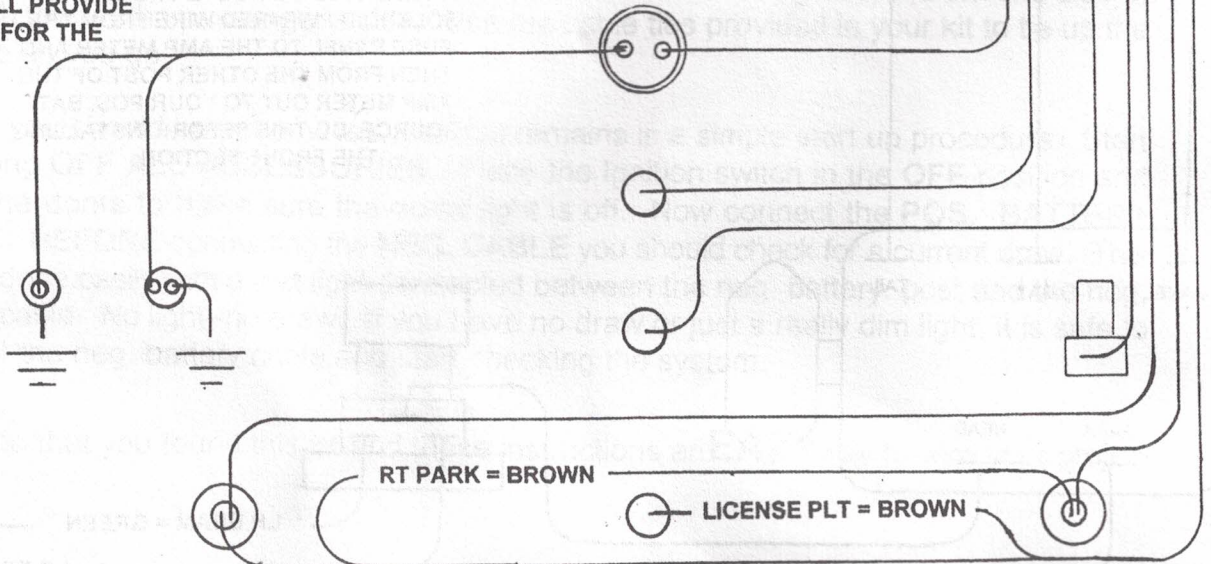

EAZY TAIL SECTION DIAGRAM

CHARGING SYSTEMS

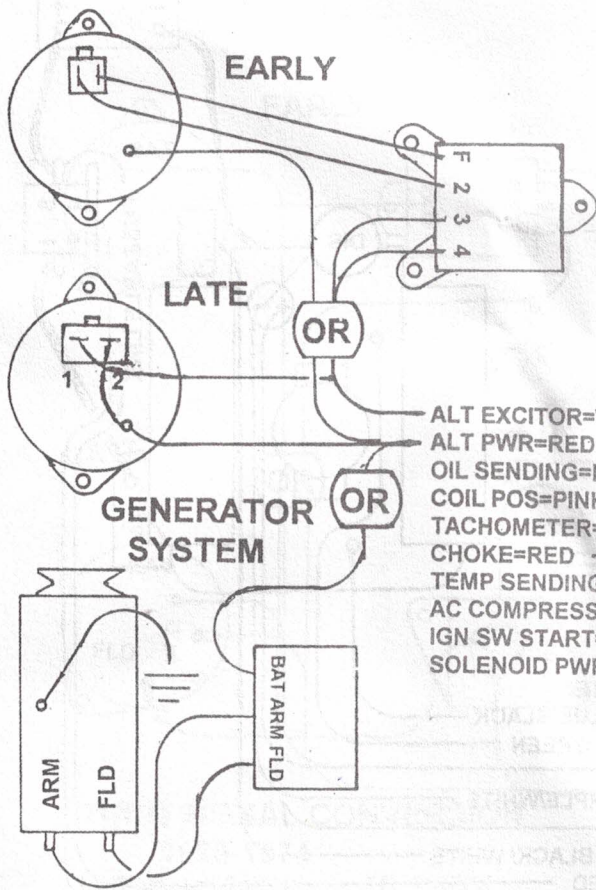

- ALT EXCITOR=WHITE
- ALT PWR=RED
- OIL SENDING=LT BLUE/BLACK
- COIL POS=PINK
- TACHOMETER=PURPLE/WHITE
- CHOKE=RED
- TEMP SENDING=LT GREEN
- AC COMPRESSOR=BLACK/WHITE
- IGN SW START=PURPLE
- SOLENOID PWR=RED

GM DIAGRAMS

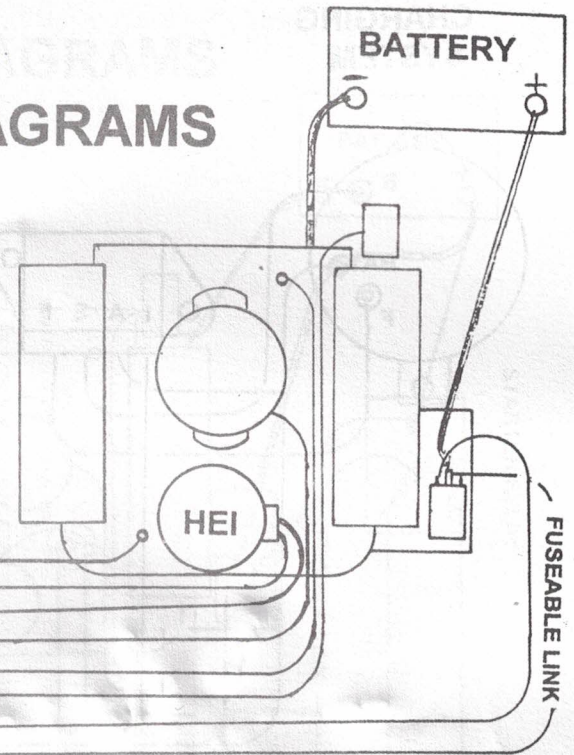

GM STANDARD IGNITION (POINTS TYPE)

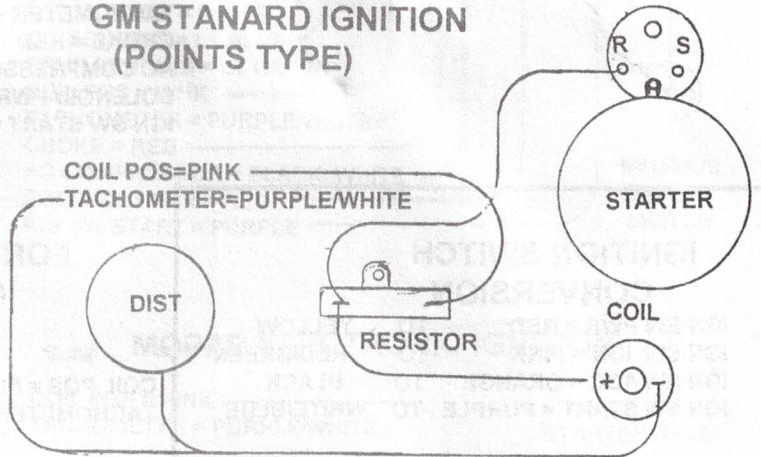

GM ONE-WIRE ALTERNATOR

IF YOU ARE USING A ONE-WIRE ALTERNATOR THE ONLY WIRE YOU NEED IS THE ALT PWR=RED WIRE. WE SUGGEST YOU STORE THE ALT EXCITOR=WHITE WIRE IN THE HARNESS IN CASE YOU NEED IT LATER.

GM TURN SIGNAL CONNECTIONS

YOUR TURN SIGNAL WIRES ARE TERMINATED FOR THE CONNECTORS THAT FIT GM COLUMNS. MEASURE THE PLUG ON YOUR COLUMN. IF IT IS 3 7/8" USE THE FLAT CONNECTOR IN YOUR KIT. IF IT IS 4 1/4" USE THE CONNECTOR WITH THE FLAP.

WIRE	CODE	GM COLOR
HORN SW=LT GREEN	G	BLACK
LF SIGNAL=LT BLUE	H	LT BLUE
RF SIGNAL=BLUE	J	BLUE
HAZZARD=DK BROWN	K	BROWN
TURN FLASHER=PURPLE	L	PURPLE
LR TURN=YELLOW	M	YELLOW
RR TURN=GREEN	N	GREEN
BRAKE SWITCH=WHITE	P	WHITE

NOTE: POINTS TYPE IGNITION SYSTEMS REQUIRE A BALLAST RESISTOR TO LOWER VOLTAGE TO THE COIL AND EXTEND POINT LIFE. FORD & MOPAR USE A RESISTOR WIRE ORIGINALLY FOR THIS, BUT YOU CAN SUBSTITUTE WITH THE CERAMIC TYPE. IT IS IMPORTANT TO ALSO INSTALL A BY-PASS WIRE SO THAT THE COIL WILL HAVE FULL VOLTAGE WHEN THE ENGINE IS CRANKING. FOR GM USE THE DIAGRAM ABOVE. FORD WIRES THE SAME BUT THE BY-PASS WIRE COMES FROM THE STARTER SOLENOID TERMINAL MARKED I. MOPAR RUNS THE BY-PASS WIRE FROM THE STARTER RELAY TERMINAL IGN.

FORD DIAGRAMS

CHARGING SYSTEM

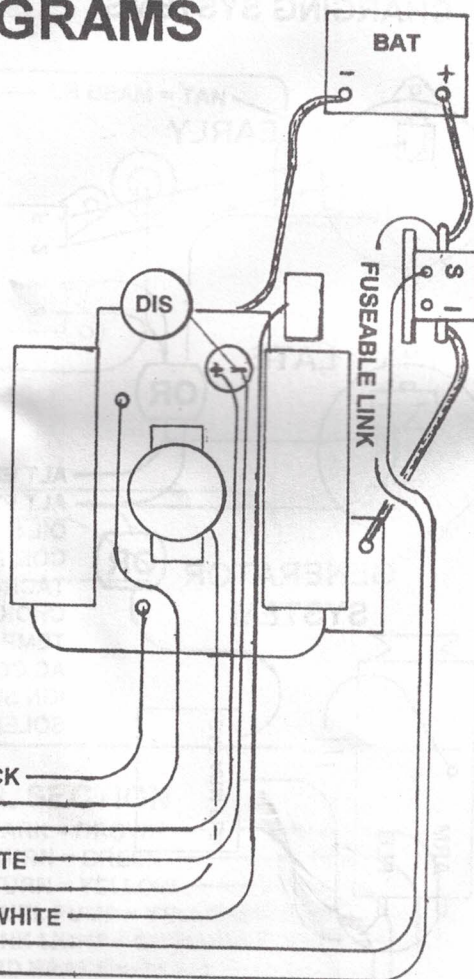
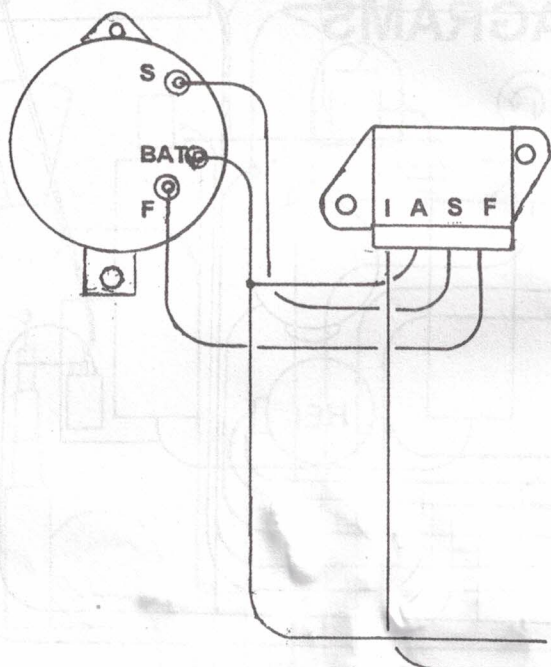

- ALT PWR = RED
- ALT EXCITOR = WHITE
- OIL SENDING = LT BLUE/BLACK
- TEMP SENDING = LT GREEN
- COIL POS = PINK
- TACHOMETER = PURPLE/WHITE
- CHOKE = RED
- AC COMPRESSOR = BLACK/ WHITE
- SOLENOID PWR = RED
- IGN SW START = PURPLE

IGNITION SWITCH CONVERSION

- | | | |
|-----------------------|----|------------|
| IGN-SW PWR = RED | TO | YELLOW |
| IGN SW IGN = PINK | TO | RED/GREEN |
| IGN SW ACC = ORANGE | TO | BLACK |
| IGN SW START = PURPLE | TO | WHITE/BLUE |

STEERING COLUMN CONVERSION

- | | | |
|-----------------------|----|--------------|
| LF SIGNAL = LT BLUE | TO | GREEN/WHITE |
| RF SIGNAL = BLUE | TO | WHITE/BLUE |
| LR TURN = YELLOW | TO | GREEN/ORANGE |
| RR TURN = GREEN | TO | ORANGE/BLUE |
| HORN SW = LT GREEN | TO | YELLOW |
| BRAKE SW = WHITE | TO | GREEN |
| TURN FLASHER = PURPLE | TO | BLUE |
| HAZZARD = DK BROWN | TO | WHITE/RED |

FORD ELECTRONIC IGNITION

- COIL POS = PINK
- TACHOMETER = PURPLE/WHITE

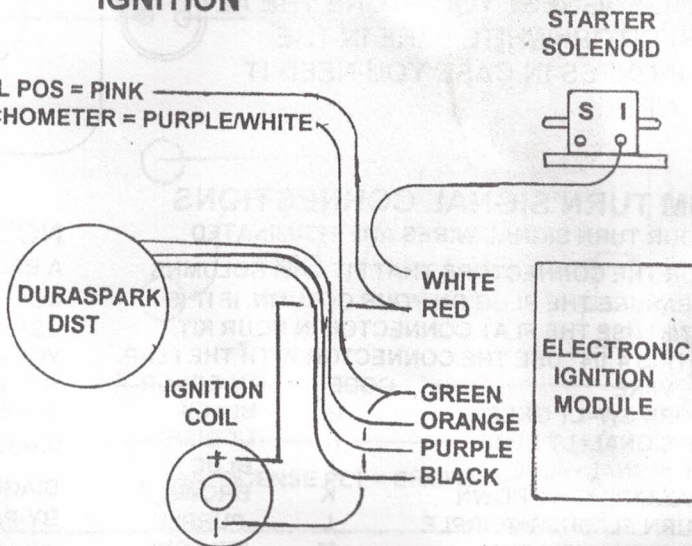

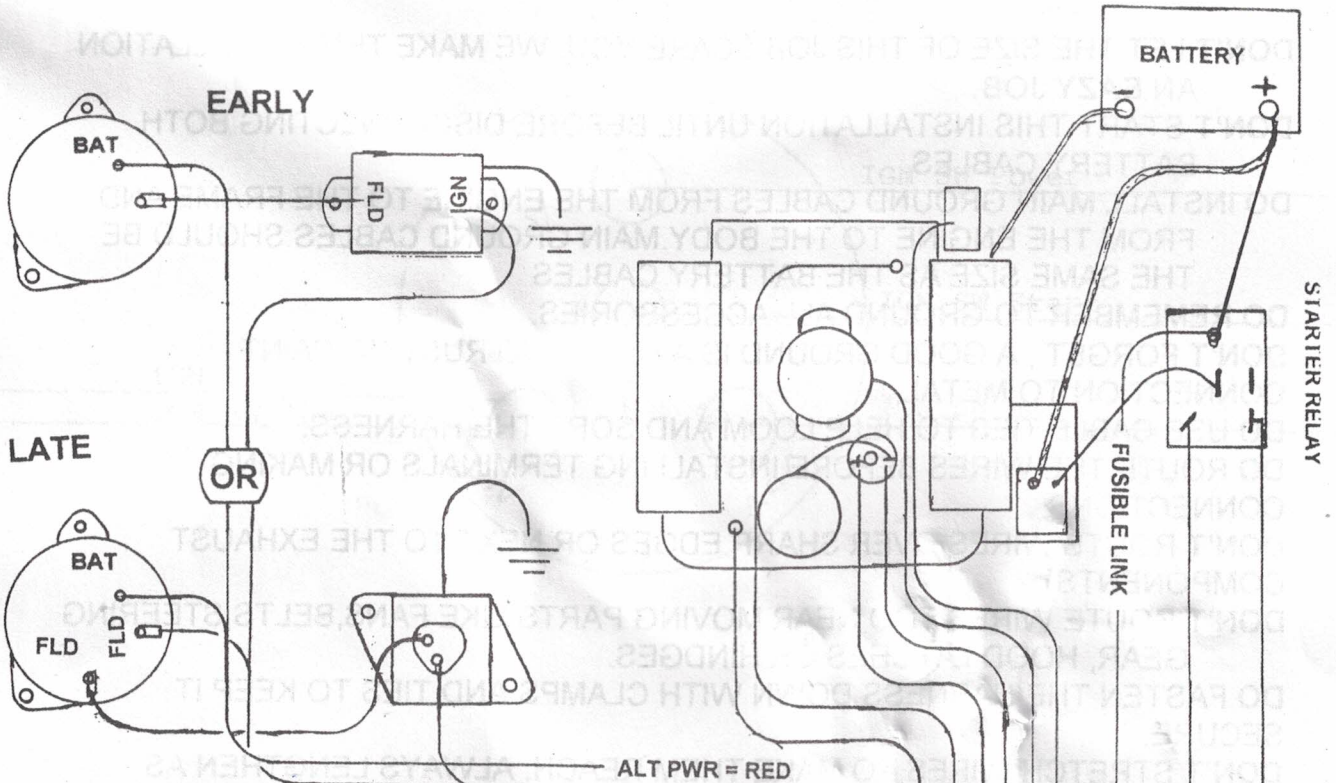

TURN SIGNAL CONVERSION

1970-1974

- | | |
|---------------------|-------------|
| LF SIGNAL=LT BLUE | TO GREEN |
| RF SIGNAL=BLUE | TO TAN |
| LR TURN=YELLOW | TO DK GREEN |
| RR TURN=GREEN | TO BROWN |
| HORN SW=LT GREEN | TO BLACK |
| BRAKE SW=WHITE | TO WHITE |
| TURN FLASHER=PURPLE | TO RED |
| HAZZARD=DK BROWN | |

- | |
|-----------------------------|
| ALT PWR = RED |
| ALT EXCITOR = WHITE |
| OIL SENDING = LT BLUE |
| TEMP SENDING = LT GREEN |
| COIL POS = PINK |
| TACHOMETER = PURPLE/WHITE |
| CHOKE = RED |
| AC COMPRESSOR = BLACK/WHITE |
| SOLENOID PWR = RED |
| IGN SW START = PURPLE |

EARLY 80'S

- | | |
|---------------------|-----------------|
| LF SIGNAL=LT BLUE | TO LT GREEN |
| RF SIGNAL=BLUE | TO TAN |
| LR TURN=YELLOW | TO DK GREEN/RED |
| RR TURN=GREEN | TO BROWN/RED |
| HORN SW=LT GREEN | TO BLACK/RED |
| BRAKE SW=WHITE | TO WHITE |
| TURN FLASHER=PURPLE | TO RED |
| HAZZARD=DK BROWN | TO PINK |

IGNITION SWITCH CONVERSION

- | | |
|---------------------|-----------|
| IGN SW PWR=RED | TO RED |
| IGN SW IGN=PINK | TO BROWN |
| IGN SW ACC=ORANGE | TO BLUE |
| IGN SW ACC=BROWN | TO BLACK |
| IGN SW START=PURPLE | TO YELLOW |

MOPAR ELECTRONIC IGNITION

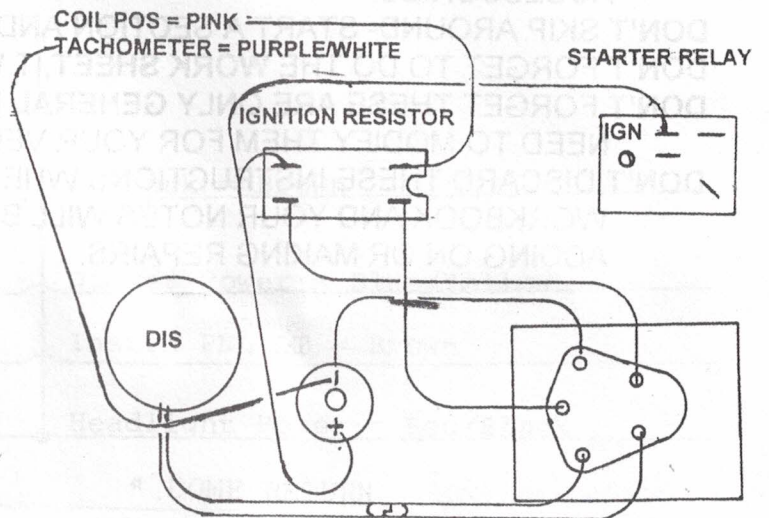

EAZY WIRING'S DO'S AND DON'TS

DON'T LET THE SIZE OF THIS JOB SCARE YOU. WE MAKE THIS INSTALLATION AN EAZY JOB.

DON'T START THIS INSTALLATION UNTIL BEFORE DISCONNECTING BOTH BATTERY CABLES.

DO INSTALL MAIN GROUND CABLES FROM THE ENGINE TO THE FRAME AND FROM THE ENGINE TO THE BODY. MAIN GROUND CABLES SHOULD BE THE SAME SIZE AS THE BATTERY CABLES

DO REMEMBER TO GROUND ALL ACCESSORIES.

DON'T FORGET , A GOOD GROUND IS A CLEAN NO RUST NO PAINT CONNECTION TO METAL.

DO USE CABLE TIES TO HELP LOOM AND SORT THE HARNESS.

DO ROUTE THE WIRES BEFORE INSTALLING TERMINALS OR MAKING CONNECTIONS.

DON'T ROUTE WIRES OVER SHARP EDGES OR NEXT TO THE EXHAUST COMPONENTS.

DON'T ROUTE WIRES TOO NEAR MOVING PARTS LIKE FANS,BELTS,STEERING GEAR, HOOD LATCHES OR HINDGES.

DO FASTEN THE HARNESS DOWN WITH CLAMPS AND TIES TO KEEP IT SECURE.

DON'T STRETCH WIRES TO MAKE THEM REACH. ALWAYS LENGTHEN AS NECESSARY.

DO USE GROMMETS WHEN PASSING WIRES THROUGH HOLES.

DO USE THE LOOM PROVIDED IN THE ENGINE COMPARTMENT.

DO USE INSULATED TERMINALS OR HEAT SHRINK OVER THE CONNECTIONS.

DO ALWAYS USE THE CORECT SIZE TERMINAL FOR THE GAUGE OF WIRE.

DON'T OVER CRIMP THE TERMINALS.

DON'T FORGET IF YOU ARE USING AN AMP METER, YOU MUST FALLOW THE SPECIAL INSTRUCTIONS ON THE DASH DIAGRAM.

DO USE THE DIAGRAMS PROVIDED WITH AFTER-MARKET OR SPECIALTY ACCESSORIES.

DON'T SKIP AROUND- START A SECTION AND FINISH IT.

DON'T FORGET TO DO THE WORK SHEET,IT WILL SAVE YOU A LOT OF TIME.

DON'T FORGET THESE ARE ONLY GENERAL INSTRUCTIONS AND YOU MAY NEED TO MODIFY THEM FOR YOUR VEHICLE.

DON'T DISCARD THESE INSTRUCTIONS WHEN YOU ARE FINISHED. THIS WORKBOOK AND YOUR NOTES WILL BE USEFUL LATER IF YOU ARE ADDING ON OR MAKING REPAIRS.

DASH IGNITION SWITCH

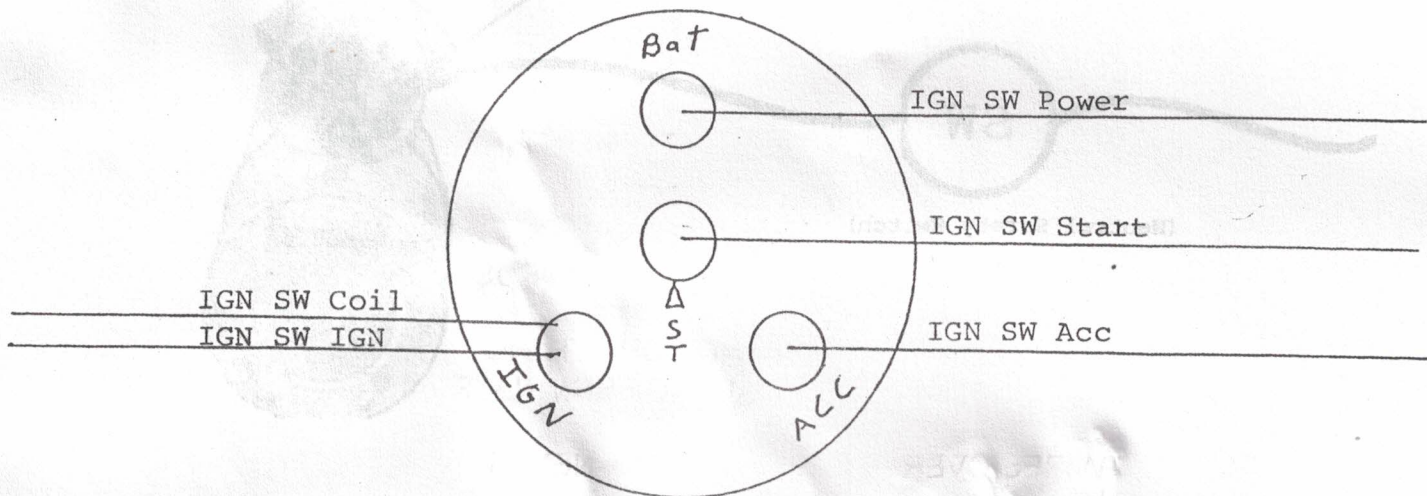

G M HEADLIGHT DIAGRAM

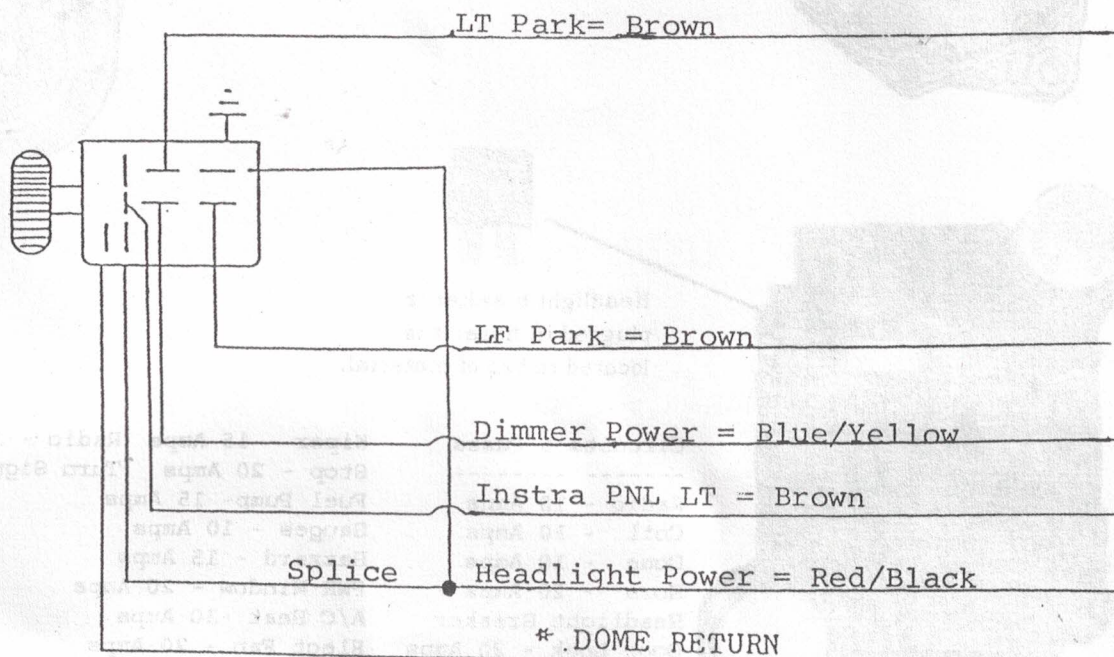

Neutral Safety Switch

You will cut the ignition switch start wire and attach both ends to each port on the switch. This ends by connecting to the "S" terminal on the starter.

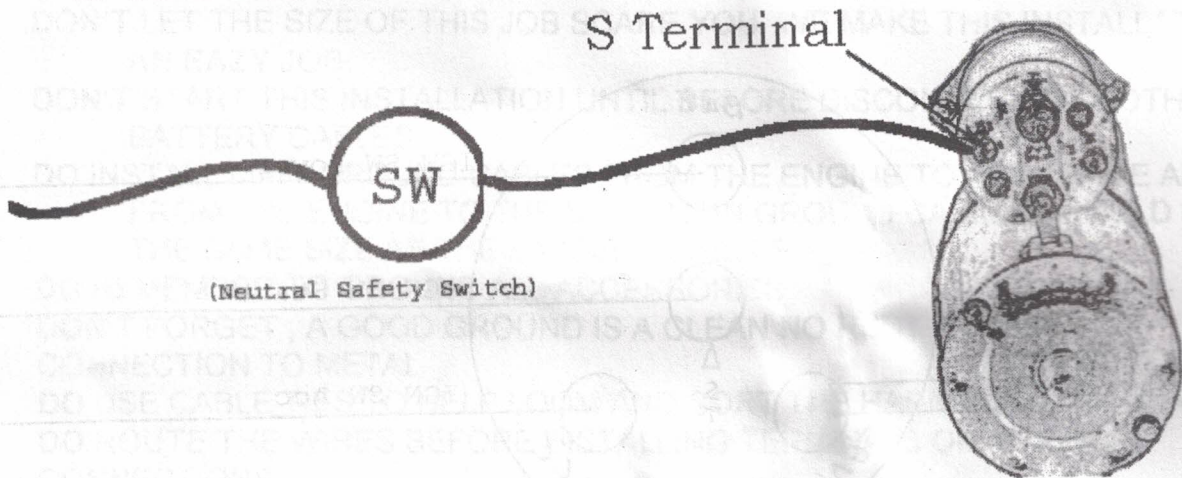

(Neutral Safety Switch)

Alternator Bypass Circuit

If You are using an 80 amp or more alternator here is the schematic for use of the bypass wire, which is included in the bag of material.

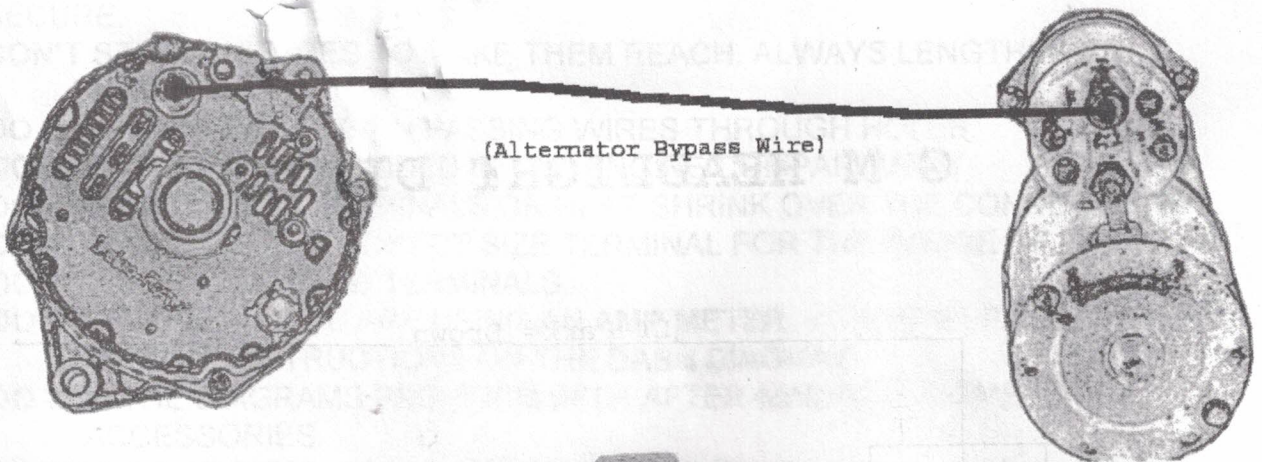

(Alternator Bypass Wire)

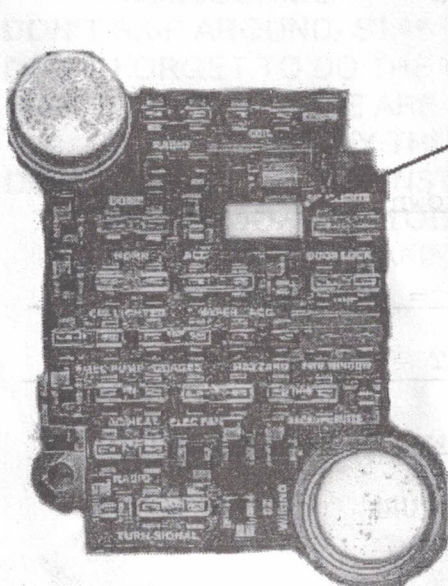

Headlight breaker is plugged in here. It is located in bag of material.

Circuits & Fuses

Radio - 10 Amps
Coil - 30 Amps
Dome - 10 Amps
Horn - 20 Amps
Headlight Breaker
Door Lock - 20 Amps
Cig Lighter - 20 Amps

Wiper - 15 Amps
Stop - 20 Amps
Fuel Pump - 15 Amps
Gauges - 10 Amps
Hazzard - 15 Amps
PWR Window - 20 Amps
A/C Heat - 30 Amps
Elect Fan - 20 Amps
Backup/Cruise - 10 Amps
Radio - 10 Amps
Turn Signal - 15 Amps